

ADS-SE

Door Side Sensor

■ Features

- Long sensing distance : 0 ~ 10m
- High ambient intensity of illumination :
Max. 100,000 lux of sunlight
- Easy to join sensor head to controller
- Easy sensitivity setting (Automatic sensitivity setting by open push method)
- Self-diagnosis function
- Compact Size (W77 × L30 × H44mm)



⚠ Please read "Caution for your safety" in operation manual before using.

■ Specifications

Model	ADS-SE	
Sensing type	Transmitted beam type	
Max. sensing distance	10m	
Power supply	12-24VAC/DC ±10% (Ripple P-P:Max. 10%)	
Power/Current consumption	AC : Max. 2VA / DC : Max. 50mA	
Contact output	Contact capacity : 50VDC 0.3A (Resistive load) Contact composition : 1c Relay life cycle : Mechanical-Min. 5,000,000 times, Electrical-Min.100,000 times	
Response time	Approx. 50ms (From light OFF)	
Output holding time	Approx. 500ms (From light ON)	
Available sensor set	2 sets	
Indicator	Operation indicator (Refer to K-65~66 for the display status in operation)	
Light source	Infrared diode (850nm modulated)	
Environment	Ambient temperature	-20 ~ + 55°C (at non-freezing status)
	Storage temperature	-25 ~ +60°C
	Ambient humidity	35 ~ 85%RH
	Storage humidity	35 ~ 85%RH
	Ambient illumination	Sunlight : Max. 100,000lx (Receiver illumination)
Protection	IP40 (IEC standard)	
Sensor wire length	10m	
Material	Case : ABS, Lens : Acrylic	
Accessory	Sensor : 1 set (ADS-SH), Fixing bolt for controller : 2 pieces	
Unit weight	Approx. 300g	

※ **Do not use Load which is beyond the rated capacity of contact point of Relay.**

It can cause bad insulation, contact fusion, bad contact, fire etc.

※ Please purchase 1 set of sensor separately when mounting 2 sets of sensor.

※ The mounting bracket of sensor is sold separately.

※ It is enable to purchase a controller separately.

Door Side Sensor

Identification

Controller part

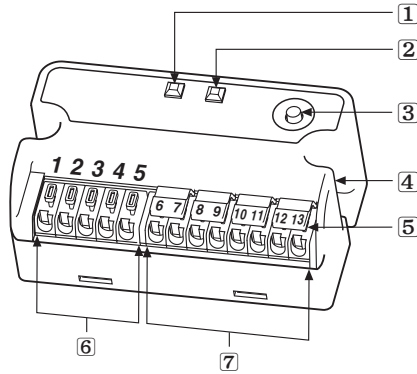

- 1 Display LED (Red)
- 2 Display LED (Green)
- 3 Sensitivity setting button
- 4 Mounting hole
- 5 Wiring connection button
- 6 Terminal for power and output (No. 1~5)
- 7 Terminal for the sensor (No. 6~13)

Sensor part

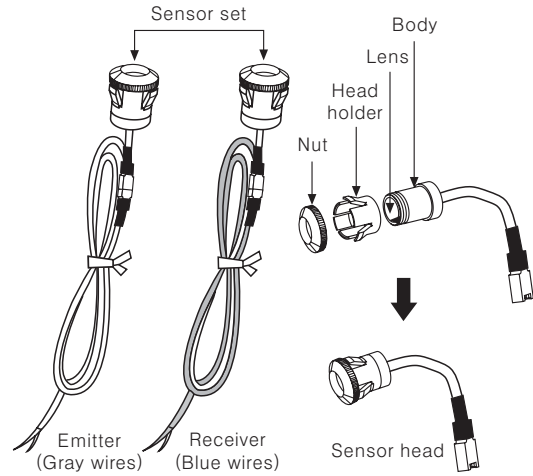

※ It is able to use 2 sets of the sensor with this product.
If it is necessary, purchase a set more for using.

Dimensions

Controller part

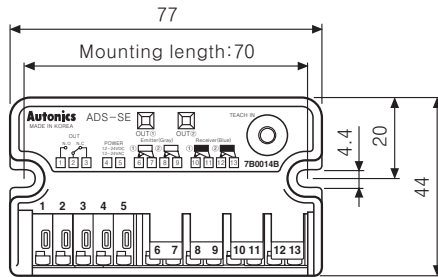

<ADS-SEC>

※ It is enable to purchase a controller (ADS-SEC) separately.

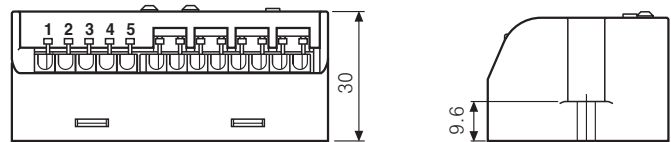

Sensor part

- One push type

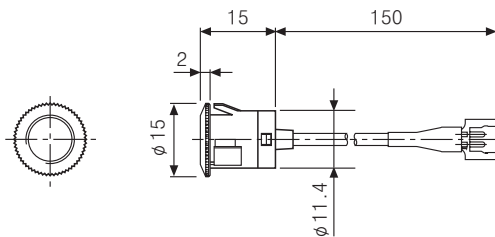

- Screw type

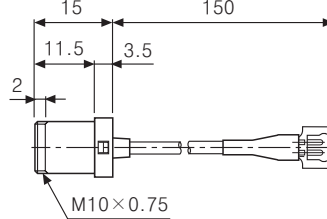

Option

- Sensor set

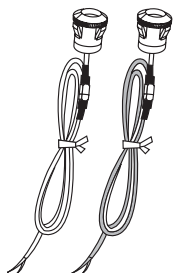

<ADS-SH>

- Bracket

<For mounting by One push>

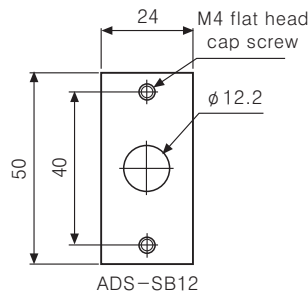

<For mounting by One Screw>

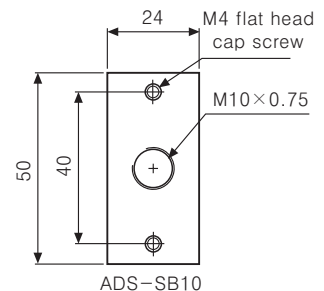

(Unit:mm)

(A) Counter

(B) Timer

(C) Temp. controller

(D) Power controller

(E) Panel meter

(F) Tacho/Speed/Pulse meter

(G) Display unit

(H) Sensor controller

(I) Switching power supply

(J) Proximity sensor

(K) Photo electric sensor

(L) Pressure sensor

(M) Rotary encoder

(N) Stepping motor & Driver & Controller

(O) Graphic panel

(P) Production stoppage models & replacement

Installation

Caution for sensor installation

1. Sensing distance is 10m.
Please install it in the rated distance.
2. Please install the sensor with more than 50cm gap from the bottom and ceiling. It may cause malfunction by reflected beams from the surface of the bottom and ceiling.
3. Please don't put obstacles between emitter and receiver.
It may cause malfunction.
4. This product is for indoor. Please avoid the place where exposed in direct sunlight or is in over rated intensity of illumination.

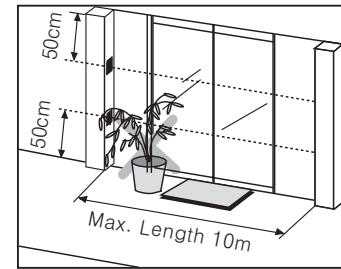

1. Please make a hole on the side post of auto door as follows.

- When not using the mounting bracket
 - Mounting hole of sensor head : $\phi 12.2\text{mm}$
- When using the mounting bracket
 - Through hole of sensor head : $\phi 13 \sim \phi 14\text{mm}$
 - Screw hole for fixing the bracket : M4 TAP or $\phi 3.5$

2. Please mount the sensor head in the mounting hole

- When not using the mounting bracket
 - One push method
Please insert the sensor head into the mounting hole like the right picture.
- When using the mounting bracket
 - One push method
 - ① Please install the sensor head at the bracket first.
 - ② Please fix the bracket by screws on the place for installing.

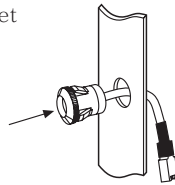

M4 flat head cap screw

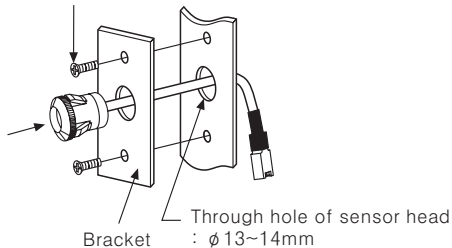

- Screw method
 - ① Please remove nuts and the head holder from the sensor head.
 - ② Please install the sensor head on the bracket.
 - ③ Please fix the bracket on the side post of the door by screws.

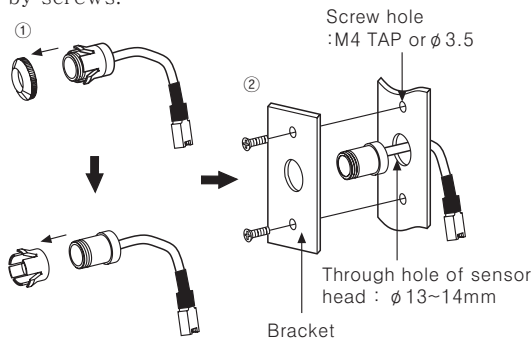

※The mounting bracket is sold separately.
If necessary, please purchase it for using.

Caution For mounting hole

- Please check the mounting holes for the head of emitter and receiver are in parallel for the optical axes.
- Please grind around the mounting holes drilled smoothly. It may hurt a person by the sharp part and cause malfunction by sensor head inclined.

Caution When installing in One push method

- Please check the nuts are fixed on the sensor body tightly.
- Please install that there is no gap between the nuts and the side of the door (or bracket).
It may cause malfunction because sensitivity setting is not available as the optical axes are not matched if sensor body is inclined.

Caution After installing the sensor head

- Please check the damage such as scratches or pollutant on the lens of the sensor head.
It may cause malfunction in the condition of shading light or lack of sensitivity by dust.

Caution For maintenance and mending

- Please keep the sensor head clean.
It may not operate normally.
Please clean it by a piece of cloth with a neutral detergent. But, do not use organic solvent.
It may cause damage to lens of the head by organic solvent.
- Do not wash the head part of the sensor.
Sensor by water, it may cause product damage.

■ Installation

■ Controller installation

- Please fix controller with the bolts (M4 × 20, 2pcs). Please process the fixing hole of controller by M4. Please refer to dimension for installation.

■ Wiring connection

1. Please follow as below when adjusting wiring length.

- ① Please cut off the wiring length as much as user needs.
- ② Please connect the wire to the terminal after taking off the wire covering. It will be easy to connect if soldering the end of the wires.

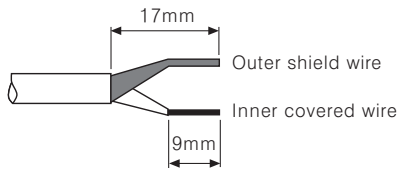

2. Please match wires in the number of terminals and connect them.

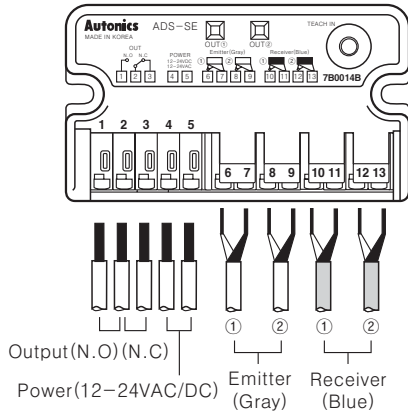

● Connection method for sensor

- Please put outer shield and inner covered wires at once, pressing the insert button, then take off from the button.

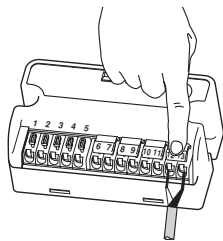

● Connection method for power and output wires

- Please put the wires pressing the terminal ends by a driver etc.

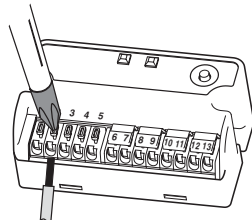

- Allowable diameter of power and output wires
 - Single wire : $\phi 0.12 \sim 1.6 \text{mm}^2$ (AWG26~16)
 - Stranded wire : $\phi 0.13 \sim 1.5 \text{mm}^2$ (AWG26~16)

⚠ Warning When fixing controller

- Please do not screw the bolts too tightly. The fixing hole of controller may be broken.

⚠ Warning It may give an electric shock.

- Please be sure of connecting wires in power off.

⚠ Caution It may cause damage to this product.

- Please follow the left picture when cutting off the wires of sensor head. If the cover of wire is taken off too much, it may cause damage to this product as the end of both wires is shorted.

⚠ Caution Do not extend the wire of sensor head.

- Please do not connect extended wire to the wire of sensor head. It may cause malfunction by noise.

⚠ Caution It may cause damage to this product.

- Please do not connect two wires or more to a terminal.

⚠ Warning Connection

- It does not operate normally if the wiring is connected conversely.

⚠ Warning It may cause damage to this product.

- Please make sure of connecting power wire to the terminal (No. 4, 5). Otherwise, it may cause damage to this product.

(A)
Counter

(B)
Timer

(C)
Temp.
controller

(D)
Power
controller

(E)
Panel
meter

(F)
Tacho/
Speed/
Pulse
meter

(G)
Display
unit

(H)
Sensor
controller

(I)
Switching
power
supply

(J)
Proximity
sensor

(K)
Photo
electric
sensor

(L)
Pressure
sensor

(M)
Rotary
encoder

(N)
Stepping
motor &
Driver &
Controller

(O)
Graphic
panel

(P)
Production
stoppage
models &
replacement

■ Proper usage

■ Sensitivity setting

Please set sensitivity after mount this product for a normal operation. It sets the optimum sensitivity automatically at the controller according to installed environment.

Order	LED display	Status
Press sensitivity setting button	Red/Green Flashed by turns	Ready
↓	↓	↓
After more than 1sec.	Red/Green All LED OFF	The beginning of sensitivity setting
↓	↓	↓
Take off from button	Flashed at once	The end of sensitivity setting
	↓	
	Displaying operation status	

Please check LED display after setting the sensitivity.

- When sensitivity setting button is pressed less than 1sec. sensitivity setting is cancelled, then it operates by previous setting.

⚠ Caution Before setting the sensitivity

- Please check the wiring again with the connection diagram.
- When set the sensitivity, the transmitted beam must not be shaken and cut off.
- Please do not put obstacles like a pot on the passage of the through beam.
- It may cause malfunction in above cases from lack of sensitivity or abnormal sensitivity setting.

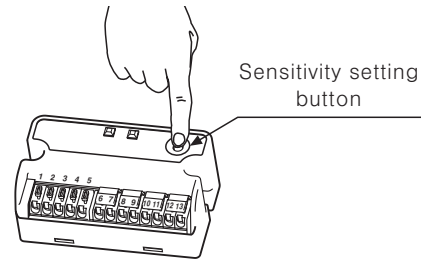

■ Sensitivity status and check after setting sensitivity

Connecting sensor	LED display		Status	
	Red	Green	After setting sensitivity	In operation
1set	LED ON <input checked="" type="checkbox"/>	LED OFF <input type="checkbox"/>	Sensitivity setting success	Light ON
	Flashing <input type="checkbox"/>	Flashing <input type="checkbox"/>	Sensitivity setting failure	Emitter disconnected or added
	Flashing <input type="checkbox"/>	LED OFF <input type="checkbox"/>	—————	Lack of sensitivity
	LED OFF <input type="checkbox"/>	LED OFF <input type="checkbox"/>	—————	Light OFF
2set	LED ON <input checked="" type="checkbox"/>	LED ON <input checked="" type="checkbox"/>	1, 2Channel sensitivity setting success	Light ON of channel 1, 2
	LED ON <input checked="" type="checkbox"/>	Flashing <input type="checkbox"/>	1Channel success, 2Channel failure	Sensitivity lock of channel 2
	LED ON <input checked="" type="checkbox"/>	LED OFF <input type="checkbox"/>	—————	Light ON of channel 1, Light OFF of channel 2
	Flashing <input type="checkbox"/>	LED ON <input checked="" type="checkbox"/>	1Channel failure, 2Channel success	Sensitivity lack of channel 1
	LED OFF <input type="checkbox"/>	LED ON <input checked="" type="checkbox"/>	—————	Light OFF of channel 1, Light ON of channel 2
	Flashing <input type="checkbox"/>	Flashing <input type="checkbox"/>	1, 2Channel sensitivity setting failure	Lack of channel sensitivity or emitter disconnected
	LED OFF <input type="checkbox"/>	LED OFF <input type="checkbox"/>	—————	Light OFF of channel 1, 2

- After complete sensitivity setting for using one set of sensor, red LED is flashing, green LED is off and only red LED displays the operation status.
- ※ After complete sensitivity setting in using two sets of sensors, red LED indicates the operation status of receiver set by receiver ① and green LED indicates the operation status of receiver set by receiver ②.
- ※ Self-diagnosis function
If lack of sensitivity occurs by optical axes not matched and pollution by dust on the lens of Emitter/Receiver etc., the LED of normal operation channel will be flickered due to unstable operation.



● Check process for sensitivity setting failure

- ① Please check obstacles between the heads of Emitter/Receiver.
 - ② Please check pollutant on the lens of Emitter/Receiver.
 - ③ Please check wires cut off and the connection with the connection diagram on the controller.
 - ④ Please check if the head of Emitter/Receiver is inclined or not.
 - ⑤ Please set sensitivity again after removing above problem.
- ※ When sensitivity setting is failure even though above problem is solved, please contact us.

Door Side Sensor

■ Operation check

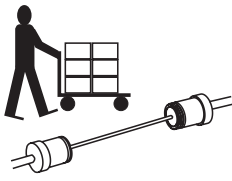
Please check the operation flow chart below.

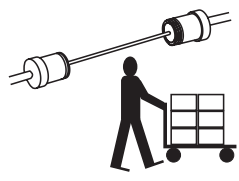
Operation					
LED display		LED OFF	LED ON (Red/Green)	LED OFF	LED ON (Red/Green)
Status		<ul style="list-style-type: none"> • Power OFF 	<ul style="list-style-type: none"> • Normal operation • No human or any material between sensors 	<ul style="list-style-type: none"> • Human or material is passing between sensors (When cutting off the transmitted beam) 	<ul style="list-style-type: none"> • After human or material is passed
Relay output	N.O	OPEN	OPEN	CLOSE	OPEN
	N.C	CLOSE	CLOSE	OPEN	CLOSE

■ Trouble shooting

Trouble	Check	Correction action
It is not work.	<ul style="list-style-type: none"> • Power voltage • Cable disconnection, incorrect connection • Rated sensing distance 	<ul style="list-style-type: none"> • Check the power cable and adjust power voltage. • Please check wiring and terminal. • Use it in rated sensing distance.
Sometimes it is not work.	<ul style="list-style-type: none"> • Pollution by pollutant on the lens of Emitter/Receiver. 	<ul style="list-style-type: none"> • Remove the pollutant.
It is operated even if people does not enter in sensing area.	<ul style="list-style-type: none"> • Rated sensing distance • There are obstacles between Emitter and Receiver. • There are equipments generating strong noise or ratio wave (Motor, Generator, High-tension wire). 	<ul style="list-style-type: none"> • Use it in rated sensing distance. • Remove obstacles. • Keep away from the equipment generating strong noise or ratio wave.

■ Caution for using

- When two sets of sensor are mounted closely, it may cause mutual interference by the emitter of other sensor. Therefore, please install them to avoid the interference by exchanging the head of Emitter and Receiver and by keeping the distance between the heads in more than 50cm.
- When sensor head is installed on the ceiling or floor closely, it may cause malfunction by receiving the reflected beam. Therefore, please install it by keeping the suitable height (more than 50cm) from the ceiling or floor.
- When the target is a translucent or small object ($\phi 15\text{mm}$ max.) it may not detect as the light transmits them.
- When wire sensor in the same pipe laying with the high-tension wire or power line, it may cause malfunction. Therefore, please use separated wiring or pipe laying.
- What sensor is used in much dusty or corroded place, it may cause malfunction. Please avoid these places when installing.
- When making the length of the wiring (power wire or output wire) long, it may cause malfunction by surge etc.
- When the lens of sensor head is polluted by dust etc., please clean it by dried cloth slightly. Do not use organic solvent like thinner.
- When switching power supply is used as the source of supplying power, please ground F.G terminal and install a condenser for removing noise between 0V and F.G terminal as following drawing.

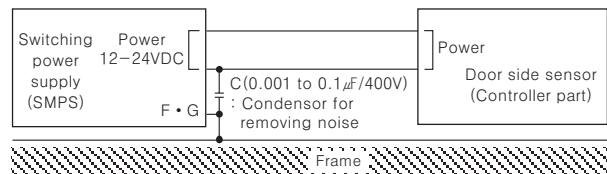

※ It may cause malfunction if above instructions are not followed.

- (A) Counter
- (B) Timer
- (C) Temp. controller
- (D) Power controller
- (E) Panel meter
- (F) Tacho/Speed/Pulse meter
- (G) Display unit
- (H) Sensor controller
- (I) Switching power supply
- (J) Proximity sensor
- (K) Photo electric sensor
- (L) Pressure sensor
- (M) Rotary encoder
- (N) Stepping motor & Driver & Controller
- (O) Graphic panel
- (P) Production stoppage models & replacement